



**A big leap  
in energy  
efficiency**

iPM series with inverter  
drive (10-100 HP)

GPMV 75

People. Passion. Performance.

 **Chicago  
Pneumatic**

# Over a 120 Years of Industrial Excellence in India

Chicago Pneumatic (CP) is a global leader in the design, manufacture and distribution of high-performance compressors. In addition to pioneering design, high impact technology and durability, Chicago Pneumatic means Customer Value. Our goal is to deliver best-in-class global service and local support to our customers through a dedicated product portfolio and a strong network of authorized distributors. We generate added value by delivering the best solution to meet your needs based on our decades of experience.

Today, CP is a global brand that offers products for countless applications and almost every industry. We are also proud to say that after all these years, CP still stands for reliability, durability and customer value.

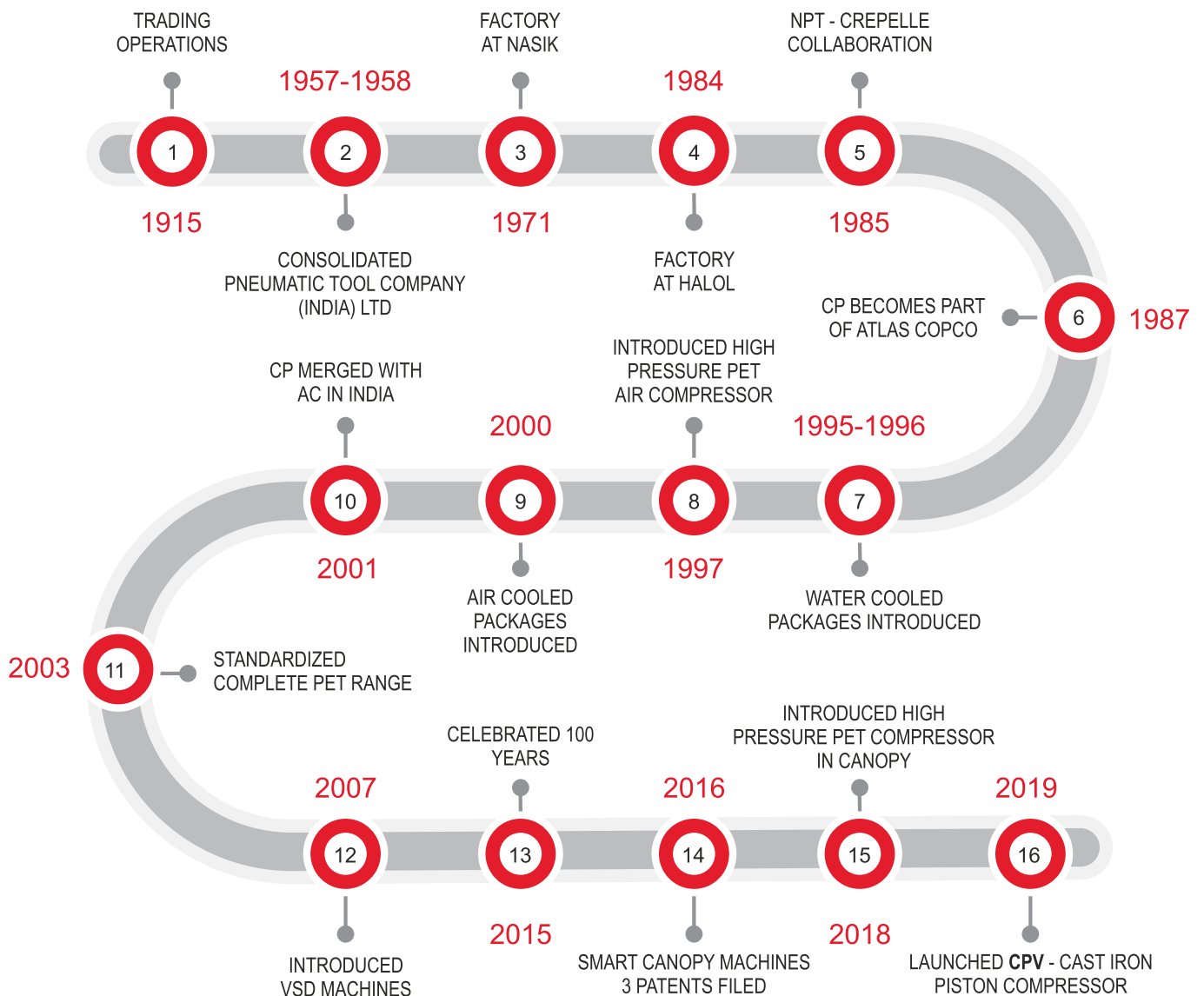

# Why iPM technology?

## Facts

- Energy costs represent about **70% - 80%** of the total cost of ownership of a compressor
- Majority of customers have a variable demand for compressed air

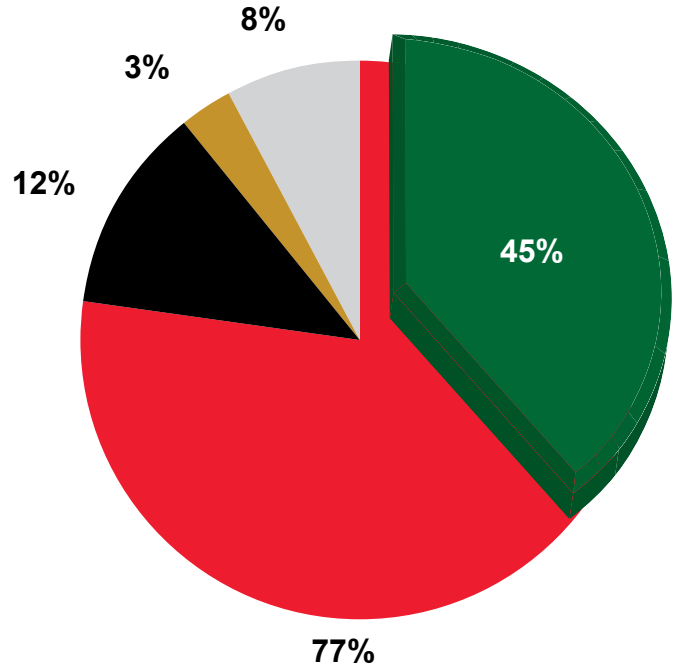

- Energy savings
- Energy consumption
- Service
- Energy savings
- Installation

## Traditional Variable Speed Technology vs. Fixed Speed Technology

- Reduced energy costs with **30-35%** in variable demand applications

## CPMV iPM vs. Fixed Speed Technology

- Reduce energy costs upto 45% in variable demand applications
- **Combined effect of :**
  1. Latest Generation Variable Speed Technology
  2. Highly energy efficient drive train with iPM motor technology.
  3. In House Designed "Screw Element"

Energy cost

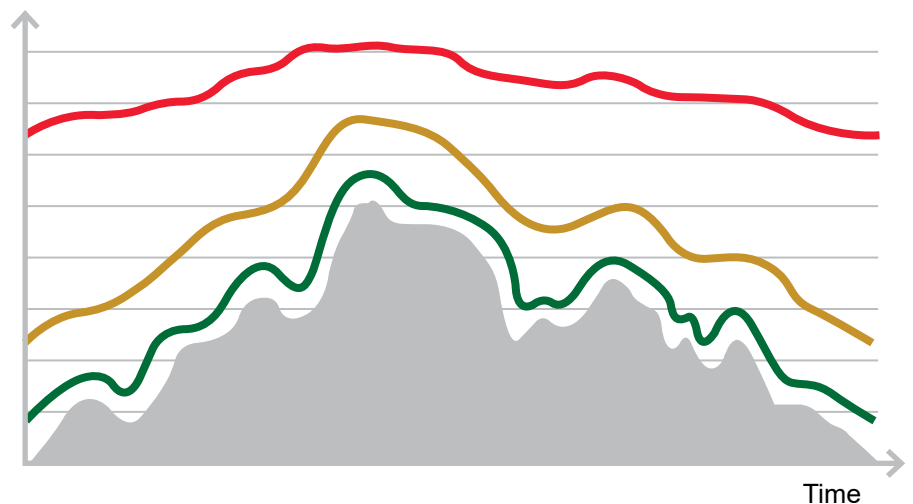

- Air Demand
- Fixed speed technology
- Variable speed technology
- iPM technology

# Oil Cooled iPM motor (Interior Permanent Magnet)

## In-house designed iPM motor

- IE4 Super Premium Efficiency (96% – 97%)
- Direct drive configuration for enhanced savings
- Latest IP Protection class
- Proven Oil cooled design
- Horizontal configuration for easy maintenance
- 100% 'In-House' design

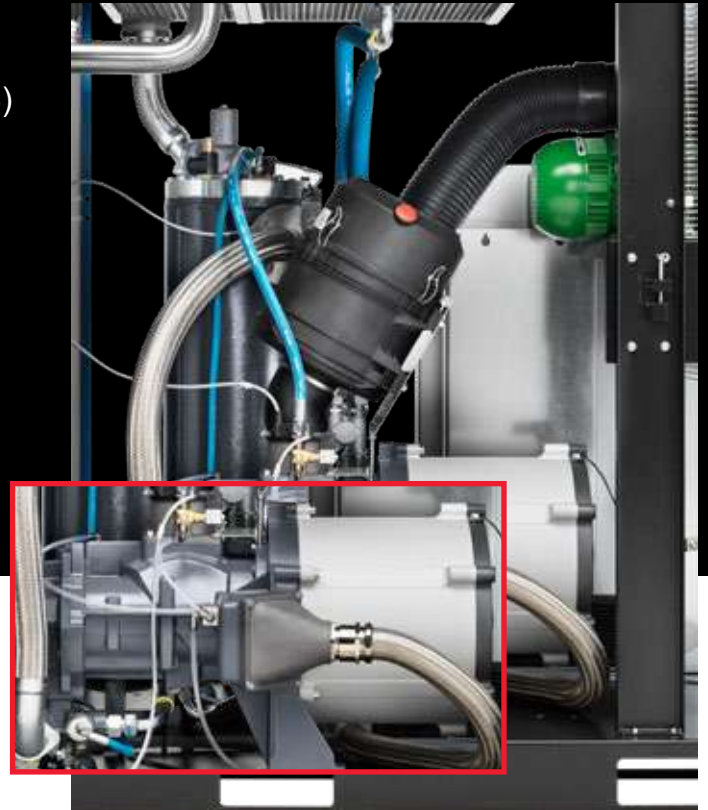

## IE4 Super Premium Efficiency iPM motor

- Upto 5% energy savings vs. IE2 / IE3 induction motor in CPMV

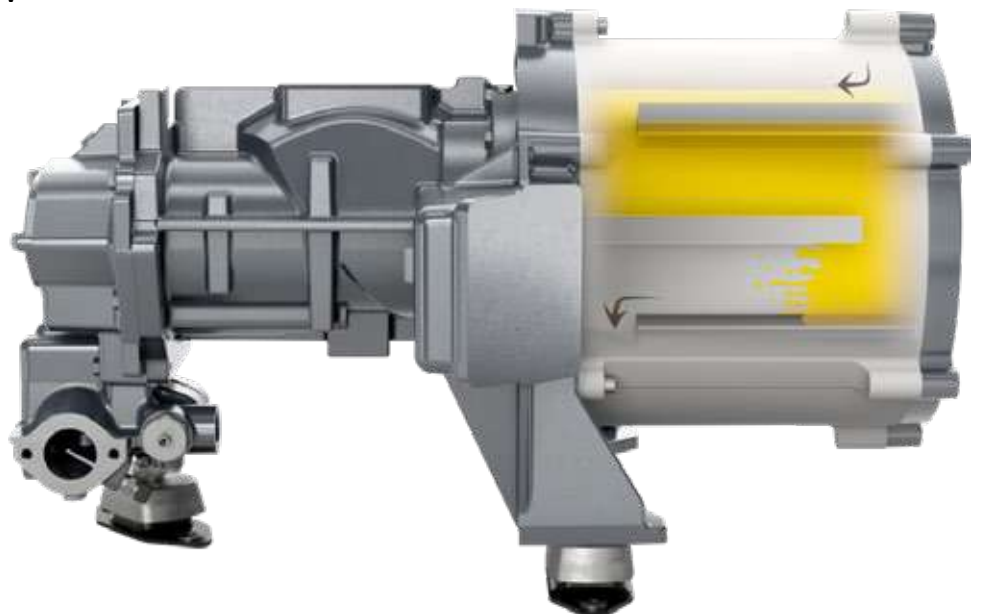

## Working principle : iPM motor

1. Permanent magnets are housed inside of the rotor (hence the name interior permanent magnet motor)
2. Electrical current flows in a rotating motion in the stator windings = Creates a rotating magnetic field
3. The permanent magnets inside the rotor will be attracted and start rotating with the magnetic field

### iPM motor construction



### IE4 Super Premium Efficiency iPM motor

- Upto 5% energy savings vs. IE2/IE3 induction motor

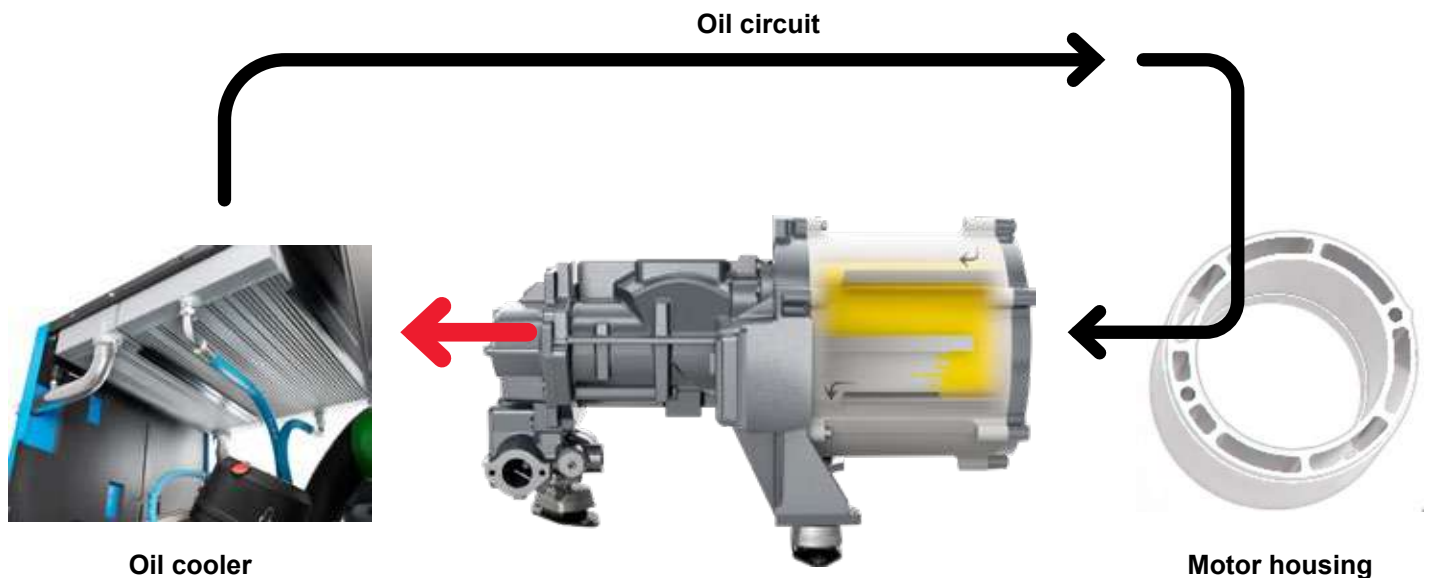

# CPMV / CPVS iPM Compressors

## Oil Cooled Direct Drive with Inverter

New innovative drive train with iPM motor technology



The proven CP IVR Design



~45%

SUPER PREMIUM EFFICIENCY  
**IE4**  
MOTOR

CPMV & CPVS (10-50 iPM)



Integrated - Inverter Drive

Horizontal Oil cooled iPM Motor technology

A big leap in energy efficiency (~45%)

## Choose from a wide range of Heavy Duty 'Latest Generation Variable Speed Drive Compressors:

1. Direct Drive (1:1) for enhanced savings
2. World Acclaimed "Horizontal Design" for EASE OF SERVICE
3. IE 4 "Super Premium Efficiency Class" 96-97%: Motor Rating
4. World Proven 'Oil Cooled' iPM Motor design reduces working temperatures.
5. Up to 45% Energy Savings (Compared with Traditional Compressors)
6. Integrated Variable Speed Drive for Maximum Savings.
7. MAM / ES 4000T Controller for Complete peace of mind\*



# Product features

## Element Design & Drive Train

- 'In-House' latest design for optimized flow rates.
- Oil cooled drive train for durable & stable commissioning usage.
- Direct Drive Configuration for excellent power transmission
- Wide Range in Pressure Band for better control.

## Usage Friendly Design

- Compact layout saving installation space
- Pre-filtration
- Quick access for regular service
- Easy clean on cooler
- Intelligent Controller
- Smart Touch Controller with RS 485
- Port for Modbus Connectivity.



## Performance

- Design for Maximum Energy Savings
- Minimum transmission loss
- 'Best-in-Class' inverter with integrated control
- High technology iPM motor for premium performance



Reliability



Friendly Usage



Energy saving



# CPMV & CPVS iPM (10-100 HP)



**Latest Generation Oil Cooled Permanent Magnet Motor**

**Smart Controller with RS 485 for Seamless Connectivity**



**In-House Design "1:1 Drive Train" for optimized Power Transmission.**









**Enhanced savings with the best in class Drive**











# Technical data

## CPMV iPM Range

Model								
	Pressure	Motor		Capacity	Noise	Weight	Connection	Dimension
	Bar	HP	KW	CFM	dB +2	kg	Inch	L X W X H (mm)
<b>CPMV PM series</b>								
CPMV 10 PM	7 - 10	10	7.5	7 - 41	73	205	3/4"	850 X 750 X 1000
CPMV 15 PM	7 - 10	15	11	10 - 61	73	205	3/4"	
CPMV 20 PM	7 - 10	20	15	17 - 73	73	205	3/4"	
CPMV 25 PM	7 - 10	25	18.5	21 - 114	73	280	1"	950 X 850 X 1080
CPMV 30 PM	7 - 10	30	22	26 - 130	73	290	1"	
CPMV 40 PM	7 - 10	40	30	49 - 187	76	362	1 1/2"	1130 X 950 X 1200
CPMV 50 PM	7 - 10	50	37	65 - 226	77	416	1 1/2"	
CPMV 60 PM	7 - 10	60	45	62 - 301	72	866	G1 1/2	1723 X 980 X 1600
CPMV 75 PM	7 - 10	75	55	65 - 389	76	1221	G2	1950 X 1090 X 1600
CPMV 100 PM	7 - 10	100	75	95 - 463	77	1285	G2	1950 X 1090 X 1600

## CPVS iPM Range

Model								
	Pressure	Motor		Capacity	Noise	Weight	Connection	Dimension
	Bar	HP	KW	CFM	dB +2	kg	Inch	L X W X H (mm)
<b>CPVS PM series</b>								
CPVS 10 PM	7 - 13	10	7.5	11 - 43	73	230	3/4"	1100 X 850 X 1080
CPVS 15 PM	7 - 13	15	11	16 - 64	73	231	3/4"	
CPVS 20 PM	7 - 13	20	15	22 - 77	73	241	3/4"	
CPVS 25 PM	7 - 13	25	18.5	30 - 121	73	313	1"	1330 X 950 X 1200
CPVS 30 PM	7 - 13	30	22	34 - 136	73	321	1"	
CPVS 40 PM	7 - 13	40	30	50 - 200	74	412	1 1/2"	1723 X 980 X 1600
CPVS 50 PM	7 - 13	50	37	67 - 227	73	413	1 1/2"	
CPVS 60 PM	7 - 13	60	45	70 - 308	70	906	G1 1/2	2259 X 1060 X 1594
CPVS 75 PM	7 - 13	75	55	57 - 401	74	1461	G2	2259 X 1060 X 1594
CPVS 95 PM	7 - 13	100	75	60 - 470	75	1535	G2	2259 X 1060 X 1594

# iPM Compressors - The One stop solution



Well designed cooling system



Latest Variable Speed Technology



Smart MAM / ES 4000T touch controller



## Latest Variable Speed Technology

- Perfectly matches air supply to air demand
- No unload losses as for fixed speed compressors
- Narrower pressure band -> lower working pressure
- No peak current at startup -> no penalties



# Calculate your savings and show them the way up to your bank!

Introducing the Future of Air Audits – “Airchitect”



## Why Airchitect?

- ÿ Up to 35% energy losses due to unload
- ÿ Every 1 bar drop in pressure output results in around 7% energy savings
- ÿ Older installation have leakages up to 20%

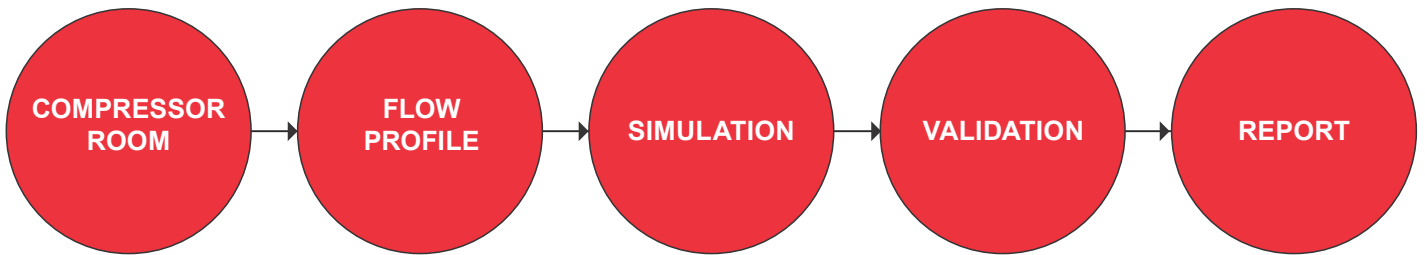

## AirXtend

Have complete peace of mind with **AirXtend**, our extended warranty plan on **Screw Element**



Be it any application, the reliable operation of your compressor is key. With our AirXtend, maintenance is done at the right time by professionals who know your equipment inside and out.

- Have a complete peace of mind with AirXtend, our extended warranty plan on Screw element.
- Using original parts and lubricants will uphold your system's energy efficiency and prevent pressure drop as all consumables are replaced on time using genuine parts.
- High uptime and energy efficiency reduce the operating cost of your compressor. In addition, AirXtend gives you maximum control over your budget.
- We give you top priority and support in case of urgent repair, after all you are an Extended Warranty + customer.
- No unnecessary spending.
- We order original parts in advance to avoid piling up of the inventory.



\*For more details contact service representative

To know more visit us at [www.cp.com/en-in/Compressors](http://www.cp.com/en-in/Compressors)



We value your feedbacks and endeavour to continuously improve our products and services.

Service ahead of time.  
Original parts, your quality assurance.

# People. Passion. Performance.

For more information, please contact your CP partner:

**Dealer Network**

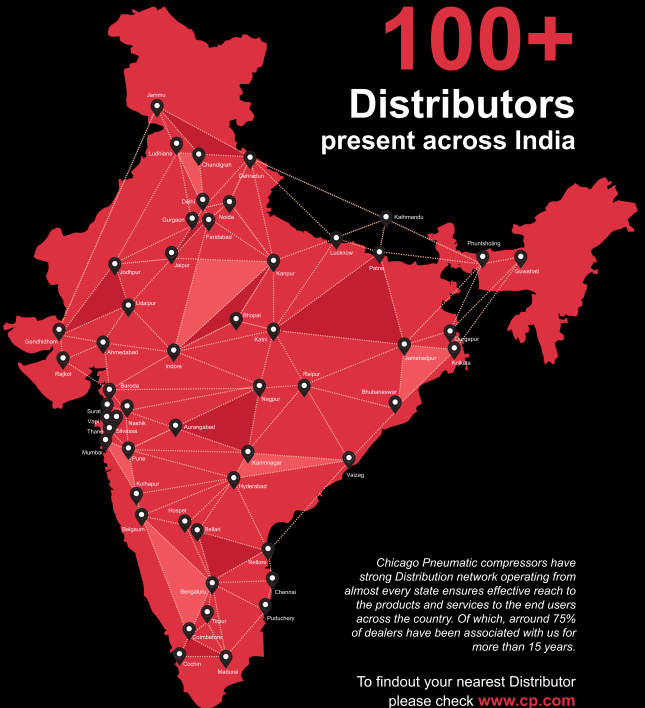

**100+**  
**Distributors**  
present across India

Chicago Pneumatic compressors have strong Distribution network operating from almost every state ensures effective reach to the products and services to the end users across the country. Of which, around 75% of dealers have been associated with us for more than 15 years.

To findout your nearest Distributor please check [www.cp.com](http://www.cp.com)

**Regional Customer Centers**

<b>West</b>	Maharashtra
<b>North</b>	Gurgaon
<b>East</b>	Kolkata
<b>Central</b>	Hyderabad
<b>South</b>	Bangalore

**Area offices:** Ahmedabad, Baroda, Chandigarh, Chennai, Pune  
**Resident offices:** Coimbatore, Erode, Kochi, Jaipur, Raipur, Vizag

**Toll Free No.: 1800 120 110 040**  
**Email: [customer.care@cp.com](mailto:customer.care@cp.com)**

